

PISCES Industries Ltd.

P.O. BOX 189
WELLS, MICHIGAN 49894
TEL: 906/789-1636
FAX: 906/789-1211

Shrimp Processing Equipment

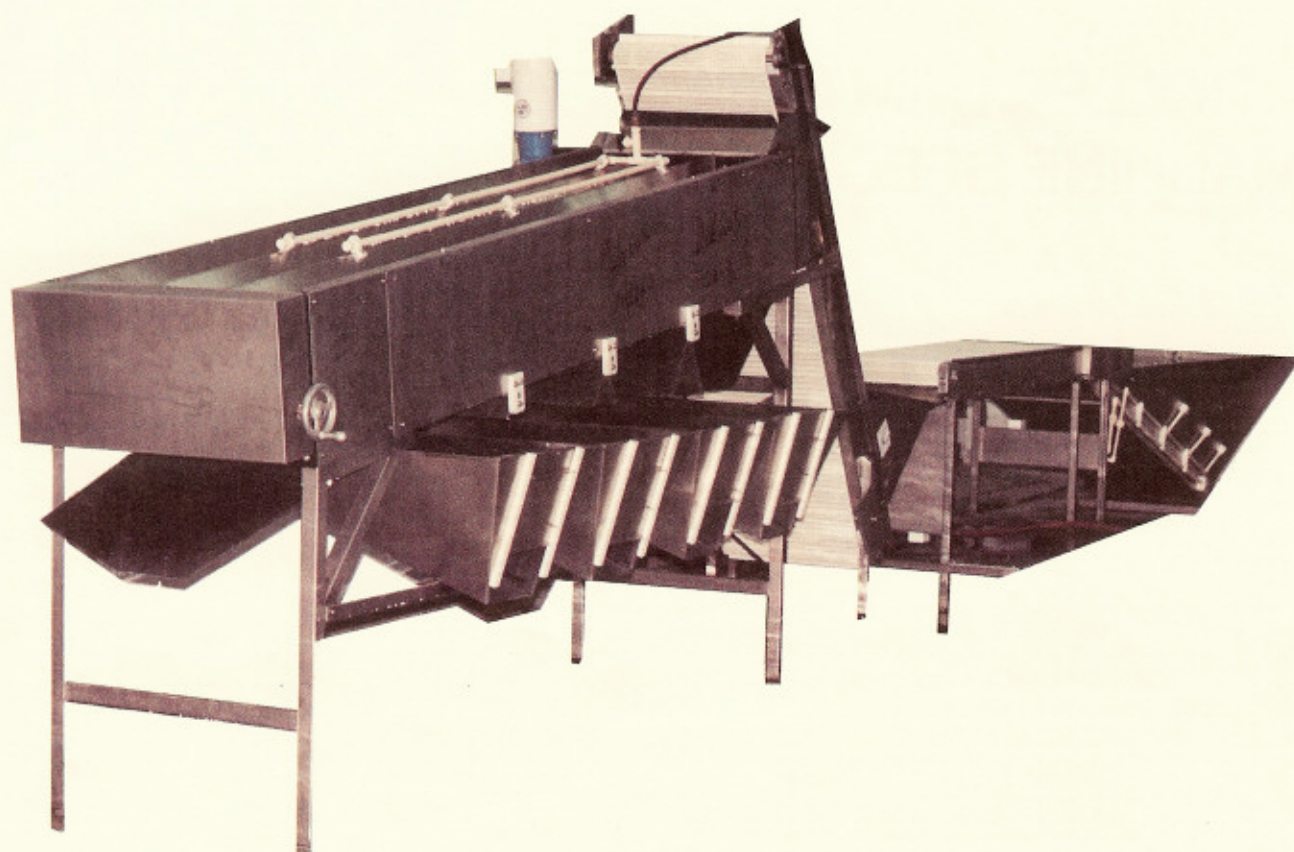

WASH RECEIVING/INSPECTION TANKS

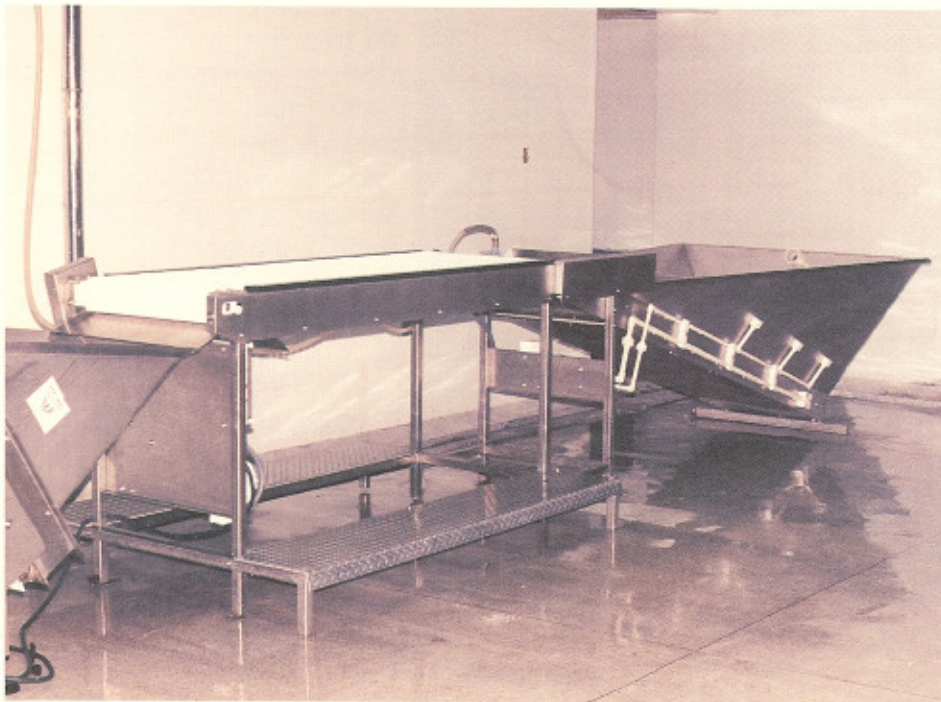

For collection and delivery of shrimp throughout the processing operation.

- All stainless steel and USDA approved materials.
- Washdown electric motors with electrical controls in waterproof enclosures.
- Inspection area with operator platforms.
- Ice baffle and adjustable product spreading paddle.

Jet Wash System Option

Agitation of the water by pumping system separates debris, ice and broken shells, etc., from the shrimp and allows for easy removal by inspectors. Soil and light debris are flooded out of the tank via the overflow system.

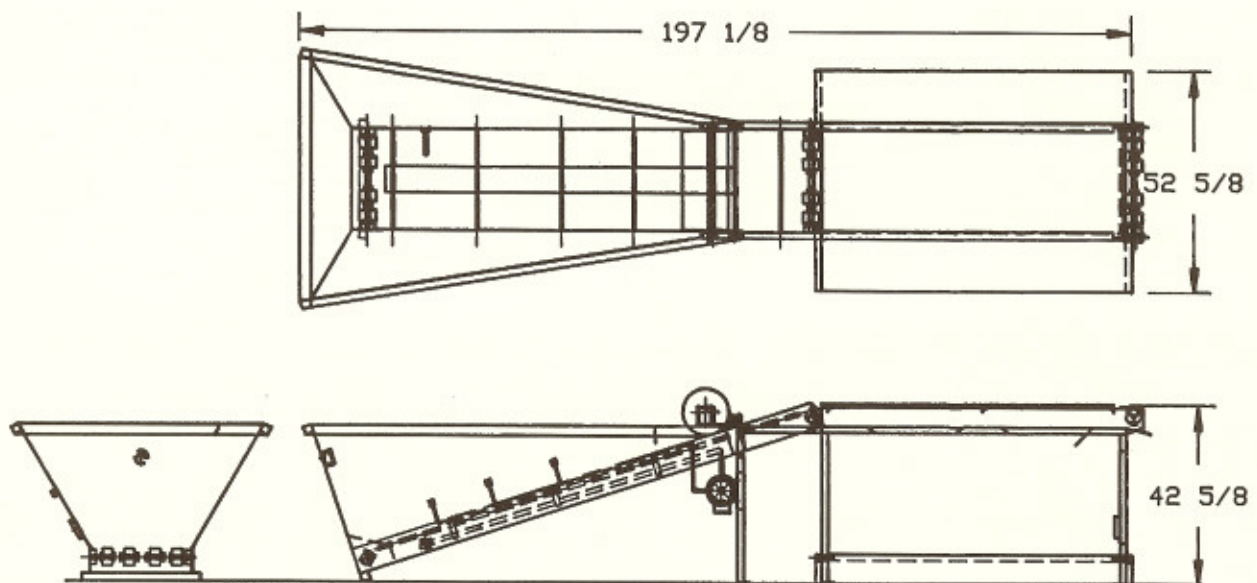

ROLLER/CAM SHRIMP GRADING MACHINES

All Pisces Shrimp Graders are manufactured from stainless steel and USDA approved materials.

- Motors are washdown and electrical controls are in waterproof enclosures.
- All bearings are nickel plated.
- Dual cam rollers are ground and polished to an accuracy of 0.005" per foot.
- Single point simultaneous roller adjustment.
- Fine adjustment split grade baffles.



No Piggybacking

The Pisces Roller/Cam system avoids the inherent problem of most roller or belt type graders whereby a smaller product can "piggyback" on a larger product and ride to an incorrect grade. The dual cams ensure product separation and individual grading.

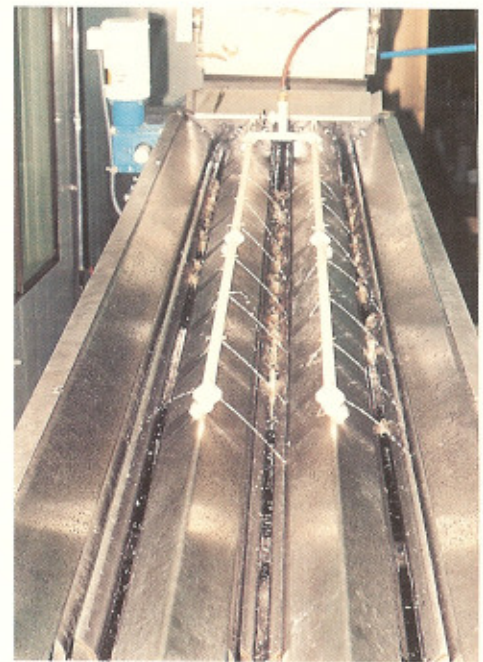

ROLLER/CAM GRADING MACHINE SPECIFICATIONS

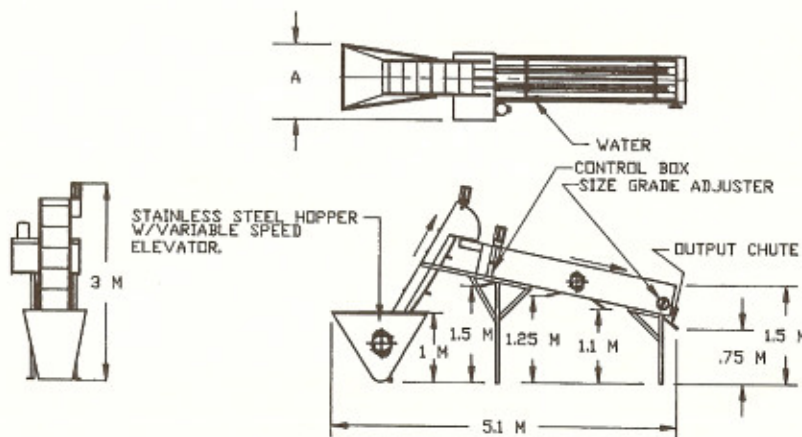

All graders provide four grades from the side, oversize going over the end.

Capacities are 1,000 lbs. per hour of head off shrimp, or 600 lbs. per hour of head on shrimp per lane of grading rollers.

MODEL NO.	A DIMENSION	CAPACITY HEAD OFF	CAPACITY HEAD ON
PG.01	15"	1000 lbs. (500 Kg)	600 lbs. (250 Kg)
PG.02	24"	2000 lbs. (1000 Kg)	1200 lbs. (500 Kg)
PG.03	33"	3000 lbs. (1500 Kg)	1800 lbs. (750 Kg)
PG.04	42"	4000 lbs. (2000 Kg)	2400 lbs. (1000 Kg)
PG.06	52"	6000 lbs. (3000 Kg)	3600 lbs. (1500 Kg)

HEAD REMOVAL SYSTEMS



Pisces head removal systems provide for maximum efficiency of head removal by hand. Product is delivered to the operator and both tail and head taken from the operator to the next process with minimum operator effort.

- All stainless steel and USDA approved materials.
- Washdown electric motors with electrical controls in waterproof enclosures.
- Provides for product delivery, head collection and tail delivery.

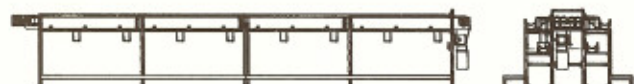
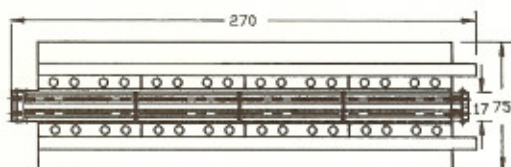

SHRIMP PROCESSING LINES

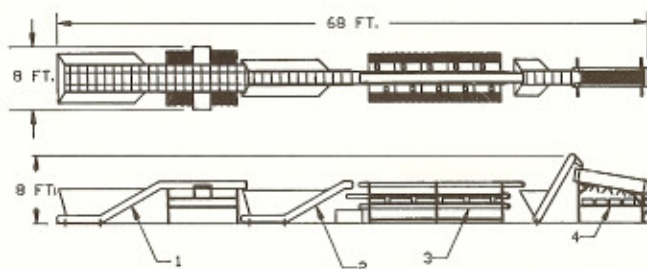

Pisces Industries Ltd. engineers will assist in the design, layout and customization of your shrimp processing plant for both head on or head off shrimp.

Manufactured by:



PISCES Industries Ltd.

P.O. BOX 189 • WELLS, MICHIGAN 49894
 TEL: 906/789-1636
 FAX: 906/789-1211

Distributed by: